

L型土止めブロック(H750額縁タイプコーナー)

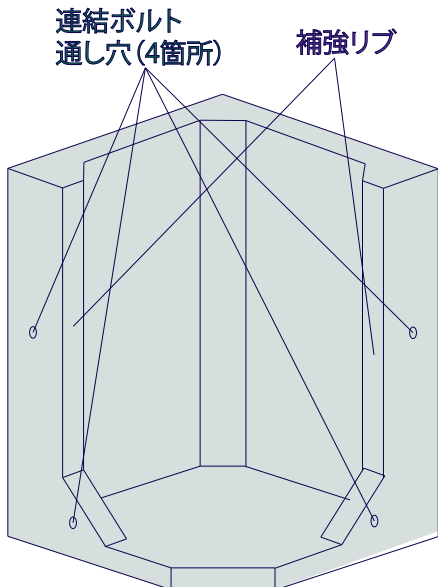
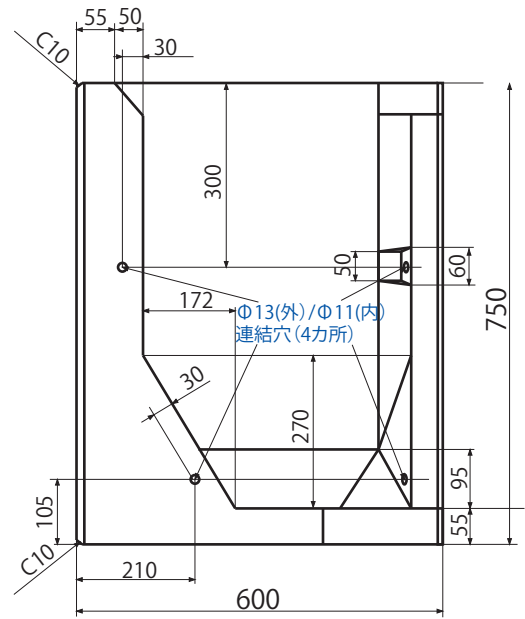
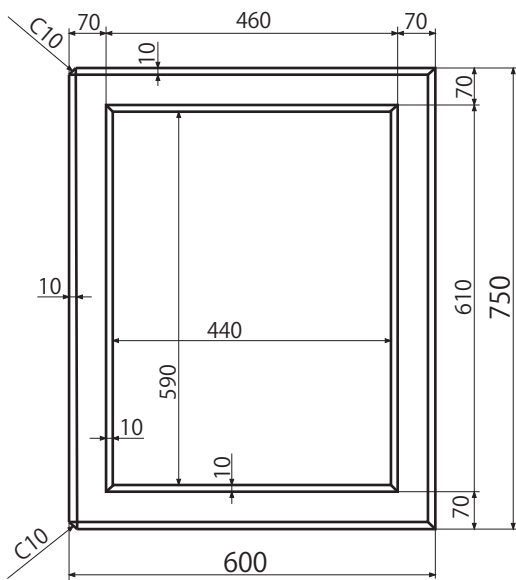
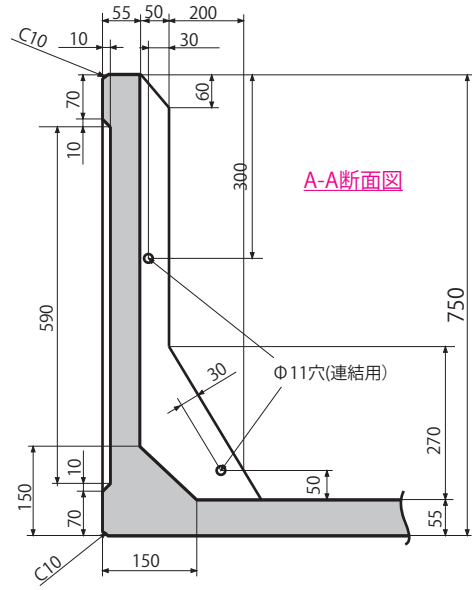
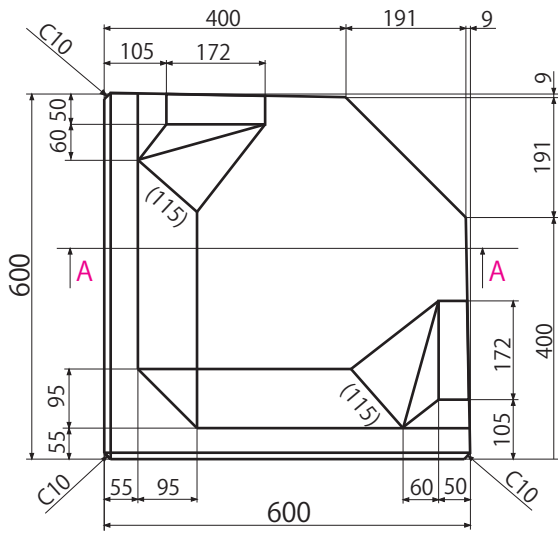

重量 150kg

(株)ヒノデコンクリート
 北海道江別市工業町7番地6
 TEL : 011-385-0960
 FAX : 011-384-8596