

L型土止めブロック (H300額縁タイプ基本)

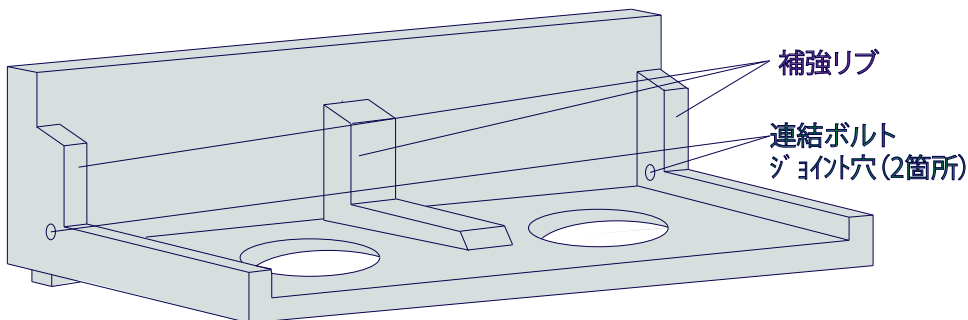
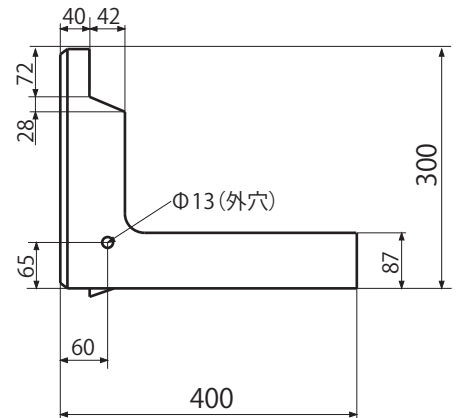
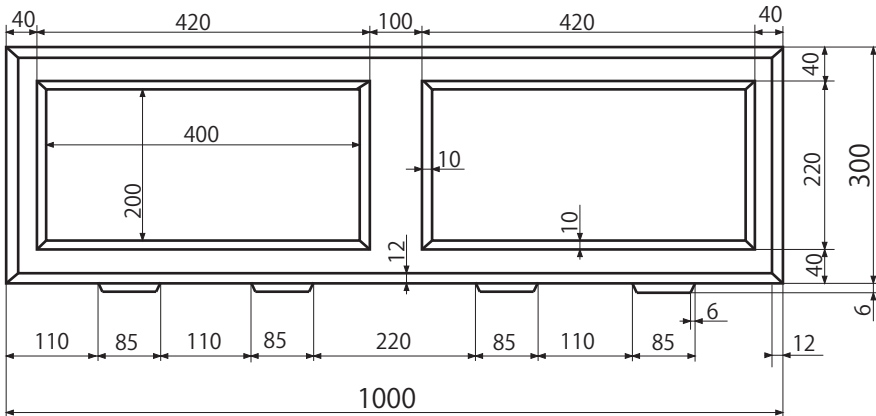
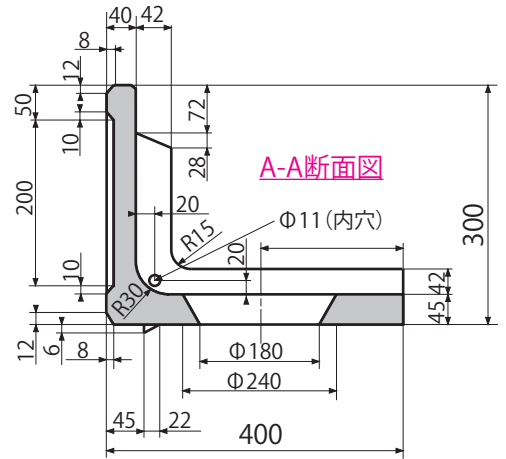
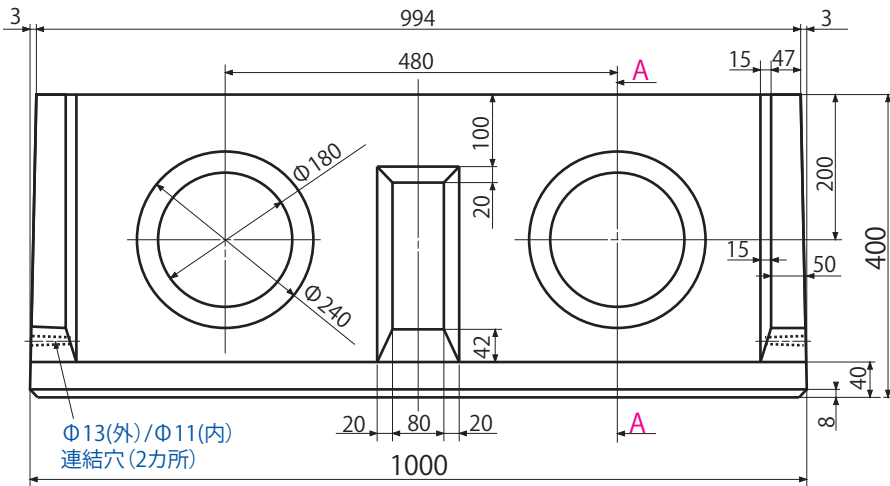

重量 62kg

(株)ヒノデコンクリート
北海道江別市工栄町7番地6
TEL : 011-385-0960
FAX : 011-384-8596